

# **VTs User's Manual**

**V 1.0.1**

# Important Safeguards and Warnings

Please read the following safeguards and warnings carefully before using the product in order to avoid damages and losses.

Note:

- Do not expose the device to lampblack, steam or dust. Otherwise it may cause fire or electric shock.
- Do not install the device at position exposed to sunlight or in high temperature. Temperature rise in device may cause fire.
- Do not expose the device to humid environment. Otherwise it may cause fire.
- The device must be installed on solid and flat surface in order to guarantee safety under load and earthquake. Otherwise, it may cause device to fall off or turnover.
- Do not place the device on carpet or quilt.
- Do not block air vent of the device or ventilation around the device. Otherwise, temperature in device will rise and may cause fire.
- Do not place any object on the device.
- Do not disassemble the device without professional instruction.

## Warning:

- Please use battery properly to avoid fire, explosion and other dangers.
- Please replace used battery with battery of the same type.
- Do not use power line other than the one specified. Please use it properly. Otherwise, it may cause fire or electric shock.

## Privacy Protection Notice

As the device user or data controller, you might collect personal data of others' such as face, fingerprints, car plate number, Email address, phone number, GPS and so on. You need to be in compliance with the local privacy protection laws and regulations to protect the legitimate rights and interests of other people by implementing measures include but not limited to: providing clear and visible identification to inform data subject the existence of surveillance area and providing related contact.

## About the Manual

- The Manual is for reference only. If there is inconsistency between the Manual and the actual product, the actual product shall prevail.
- We are not liable for any loss caused by the operations that do not comply with the Manual.
- The Manual would be updated according to the latest laws and regulations

of related regions. For detailed information, see the paper User's Manual, CD-ROM, QR code or our official website. If there is inconsistency between paper User's Manual and the electronic version, the electronic version shall prevail.

- All the designs and software are subject to change without prior written notice. The product updates might cause some differences between the actual product and the Manual. Please contact the customer service for the latest program and supplementary documentation.
- There still might be deviation in technical data, functions and operations description, or errors in print. If there is any doubt or dispute, please refer to our final explanation.
- Upgrade the reader software or try other mainstream reader software if the Guide (in PDF format) cannot be opened.
- All trademarks, registered trademarks and the company names in the Manual are the properties of their respective owners.
- Please visit our website, contact the supplier or customer service if there is any problem occurred when using the device.
- If there is any uncertainty or controversy, please refer to our final explanation.

# Table of Contents

Important Safeguards and Warnings.....	ii
Special Announcement .....	错误!未定义书签。
1. Product Overview .....	1
1.1. Product Intro .....	1
1.1.1. Product Description .....	1
1.1.2. Features.....	1
1.2. Device Structure .....	1
1.2.1. Front Panel .....	1
1.2.2. Rear Panel.....	3
2. Wiring.....	5
2.1. Device Wiring.....	5
2.2. Device Networking.....	5
3. Project Setup .....	6
3.1. Login Interface .....	6
3.2. Device Info.....	6
3.3. Add VTH/Fence Station.....	7
3.4. SIP Server .....	9
3.5. Add IPC .....	10
3.6. Call Test.....	11
3.7. Default .....	12
4. Daily Operation.....	13
4.1. Monitor.....	13
4.2. Call.....	15
4.2.1. Shout.....	15
4.2.2. Call Resident .....	16
4.2.3. Call Record .....	17
4.3. Message .....	19
4.4. Unlock.....	20
4.5. Version.....	21
4.6. Basic Config.....	21
4.6.1. Display .....	21
4.6.2. Ring.....	21
4.6.3. Talk Time.....	22
4.6.4. SD Card .....	23
4.6.5. Default.....	23
Appendix 1 .....	24

# 1. Product Overview

## 1.1. Product Intro

### 1.1.1. Product Description

VTS as the contact center and service center of a system, can:

- Bidirectional video walk among guest, VTH, VTO and fence station.
- Monitor IPC, VTO and fence station.
- Remote lock.
- VTH, VTO can one-click call VTS.

### 1.1.2. Features

- Easy operation, no installation required, bracket 0~45° adjustable.
- Max manage 50 VTS.
- Simultaneously multi-channel monitor, max support 4-ch 720P.
- Capacitance touch screen 10 inch LCD, human-computer interaction.
- Hands-free call and handset.
- SD card expansion
- 2-ch USB port
- 1-ch HDMI output, max resolution 1024\*600.

## 1.2. Device Structure

Device supports desktop position, and you can adjust its position and angle (0~45° ) via adjustment level at rear.

### 1.2.1. Front Panel

See Figure 1-1.

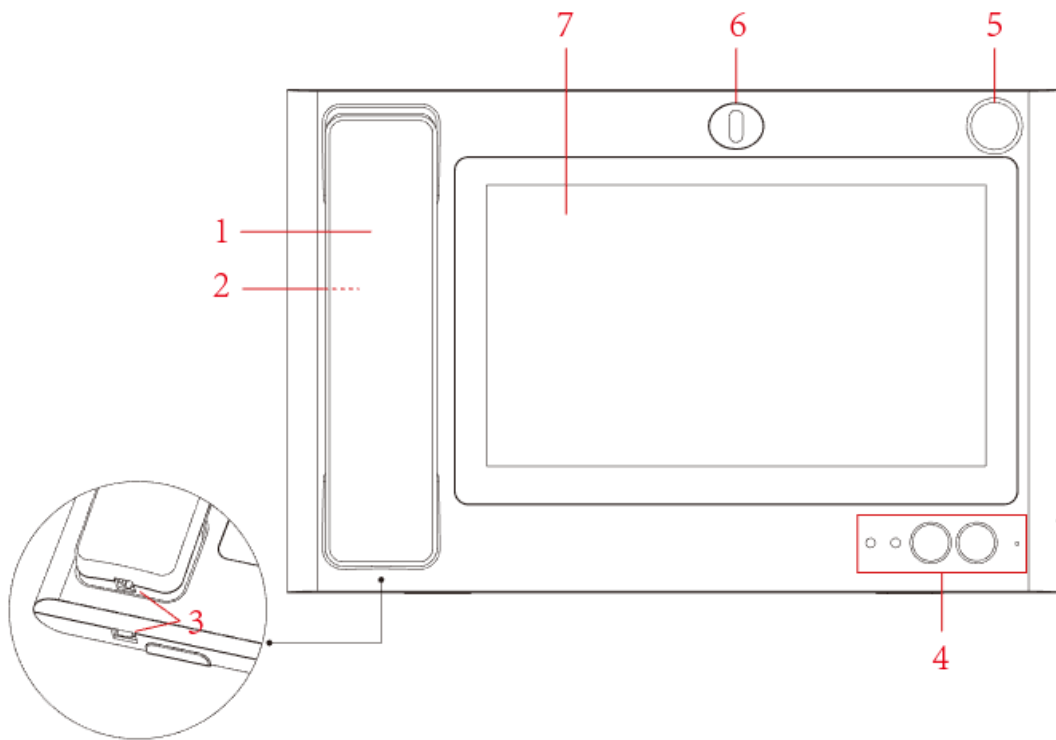

Figure 1-1

Please refer to the following sheet for detailed information.

No.	Parameter	Note
1	MIC	Lifts MIC, audio and pickup are both on MIC.
2	Speaker	Sound output.
3	Telephone Port	Connect VTS and MIC.
4	Indicator	<p>From left to right:</p> <ul style="list-style-type: none"> <li>● Power indicator If the indicator is on, it indicates that the device is powered on. If the indicator is off, it indicates that the device is not connected to the power supply.</li> <li>● Information indicator If the indicator light is on, it indicates that the device has a missed call. The indicator light is off, indicating that the missed call has been processed or there is no missed call.</li> <li>● Unlock button In the status of being called, monitoring status, call status management machine, press the device on the unlock button, you can remotely open the door machine door lock.</li> <li>● Hands-free button Used to answer incoming calls, switch handsfree or Handset mode.</li> <li>● Built-in MIC</li> </ul>

No.	Parameter	Note
		Sound input.
5	MIC	(optional) can connect to external gooseneck MIC
6	Camera	(optional) adjust up and down for camera angle
7	Display and Touch	Screen and touch area.

## 1.2.2.Rear Panel

See Figure 1-2.

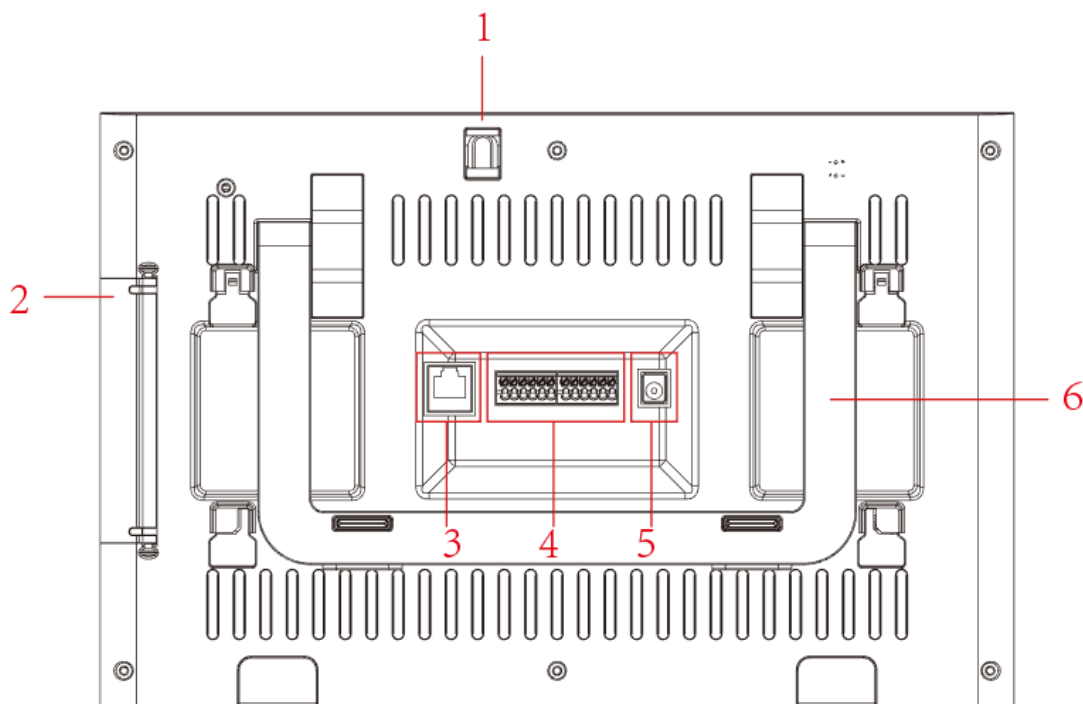

Figure 1-2

No.	Parameter	Note
1	Camera	Adjust camera angle up and down.
2	Port	Open rear cover, ports from up to down: <ul style="list-style-type: none"> <li>● HDMI video transmission port, for video only.</li> <li>● USB port.</li> <li>● USB port.</li> <li>● SD card slot.</li> </ul>
3	Network Port	Plug in RJ45 Ethernet cable.
4	12-pin Port	Ports from left to right are: <ul style="list-style-type: none"> <li>● Power output port</li> <li>● GNS</li> <li>● Alarm input port 1.</li> </ul>

No.	Parameter	Note
		<ul style="list-style-type: none"> <li>● Alarm input port 2.</li> <li>● Alarm input port 3.</li> <li>● Alarm input port 4.</li> <li>● Power input port.</li> <li>● GND.</li> <li>● RS485A port.</li> <li>● RS485B por.</li> <li>● Alarm output port NO.</li> <li>● Alarm output port COM.</li> </ul>
5	Power Port	DC 12V power
6	Bracket	Place VTS on desktop, adjust level to adjust VTH to an appropriate position.



## 2. Wiring

### 2.1. Device Wiring

- Please use our standard power supply, not self-powered.
- Before wiring, please understand the structure of the device. For details, refer to Ch 1.2.
- Before turning on the power, make sure all wiring is correct. Power running, the normal working state for the power indicator light is always red.

### 2.2. Device Networking

See Figure 2-1.

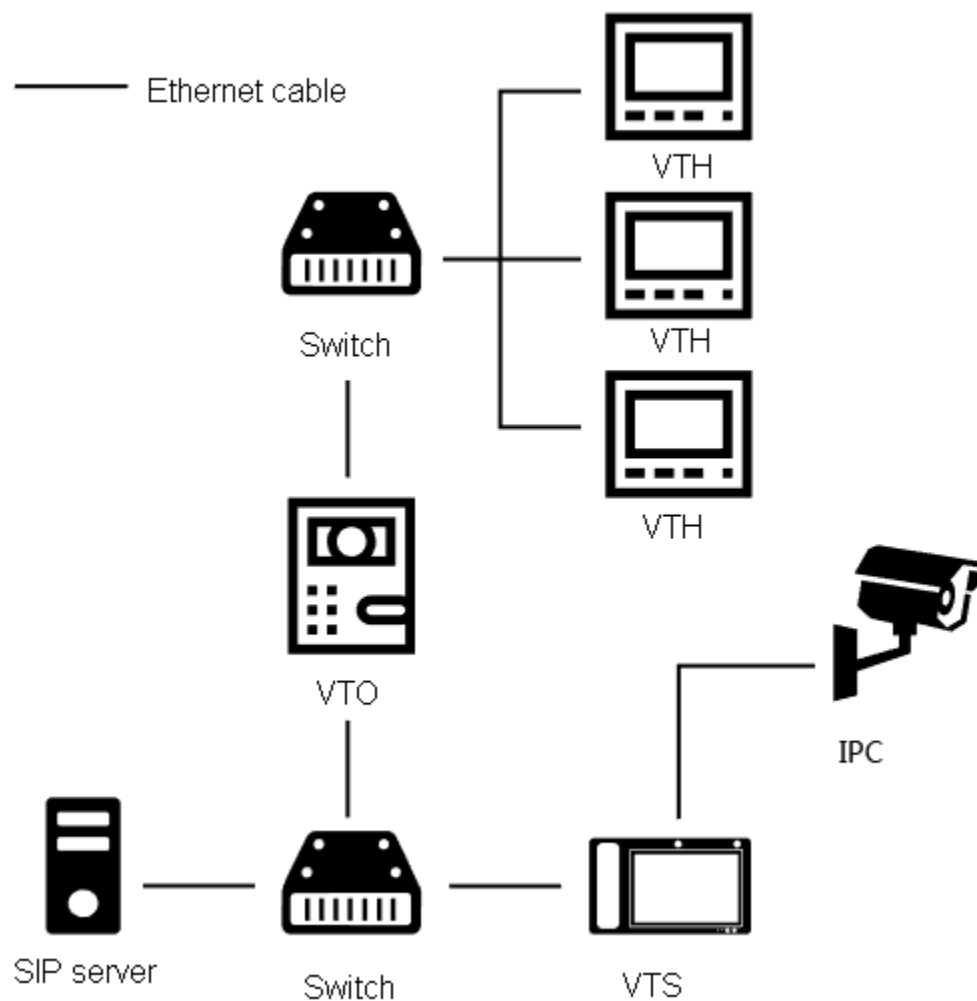

Figure 2-1

## 3. Project Setup

Note:

Before operation, please make sure the device has properly wired, see Ch 2.1.

### 3.1. Login Interface

After device boots up, see Figure 3-1.

In login interface, enter login password, enter OK.

Note:

Default login password is 123456, and you cannot modify this password.

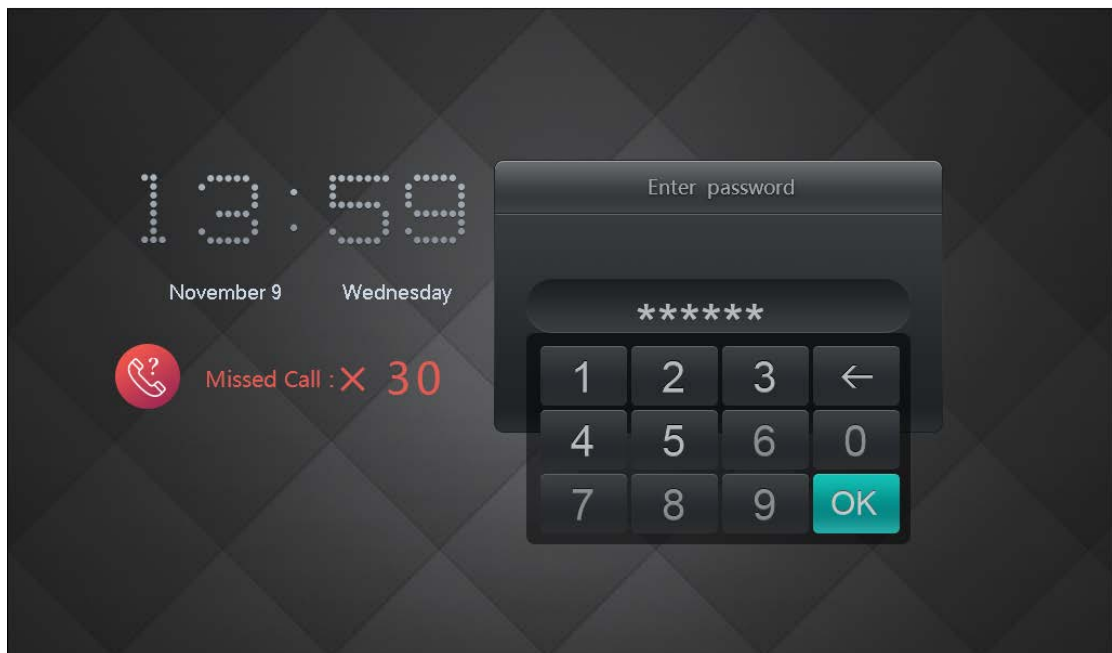

Figure 3-1

### 3.2. Device Info

Go to Config>Advance Config>Product Set Info, set no., local IP, subnet mask and etc, see Figure 3-2.

Note:

- Advance Config interface default login password is 888888, and you cannot modify this password.
- Please enter set IP address on Local IP field which must be in the same network

segment with VTO, VTH and matched device.

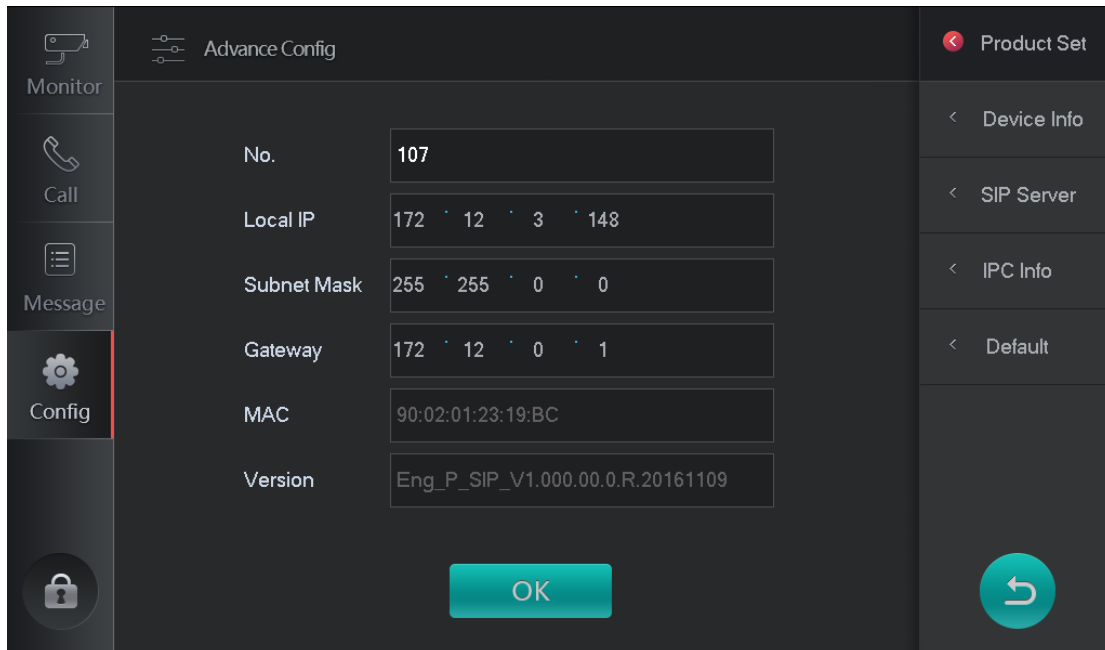

Figure 3-2

### 3.3. Add VTH/Fence Station

You can go to Config>Advance Config>Device Info, add one or batch one VTO/fence station.

For example to add VTO:

Warning:

Before config, please make sure the VTO is plugged to power and is in the same network with VTS.

- Add one VTO

Step 1. Select Setup>Advance Config>Device Info. See Figure 3-3.



Figure 3-3

Step 2. Click VTO.

Step 3. Click Add. See Figure 3-4.

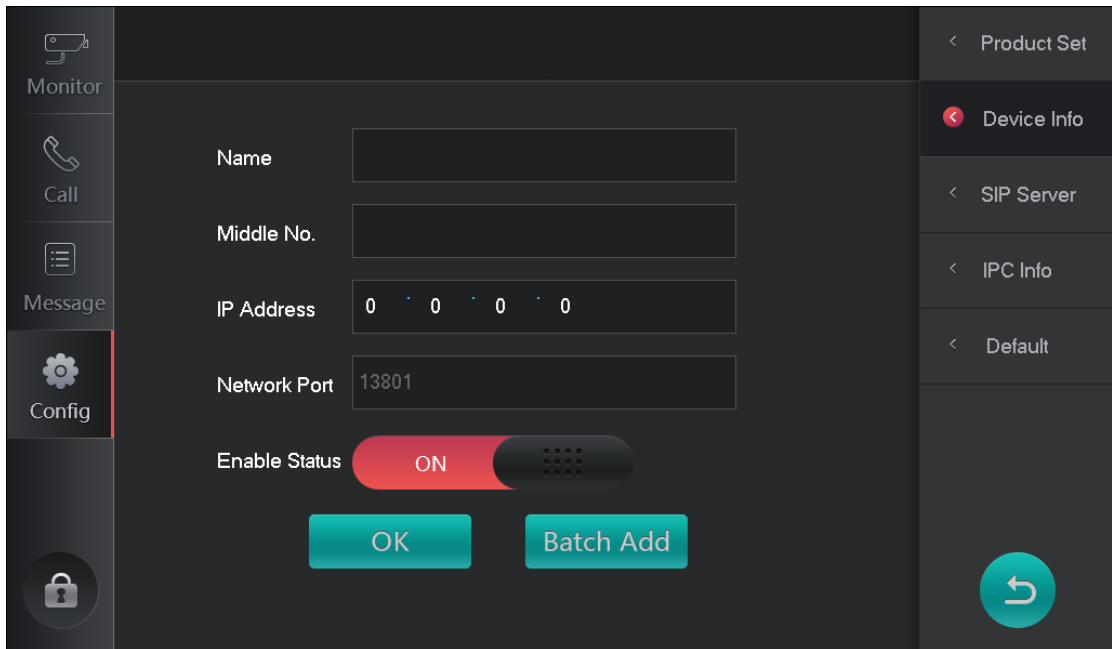

Figure 3-4

Step 4. Enter VTO name, IP address, and set Enable Status.

Step 5. Click OK. System shows “please wait” interface, click OK to continue adding VTO.

Successfully added VTO can be added in Monitor>VTO.

- Batch add VTO

Step 1. Select Config>Advance Config>Device Info.

Step 2. Click VTO.

- Step 3. Click Add.
  - Step 4. Click Batch Add.
- See Figure 3-5.

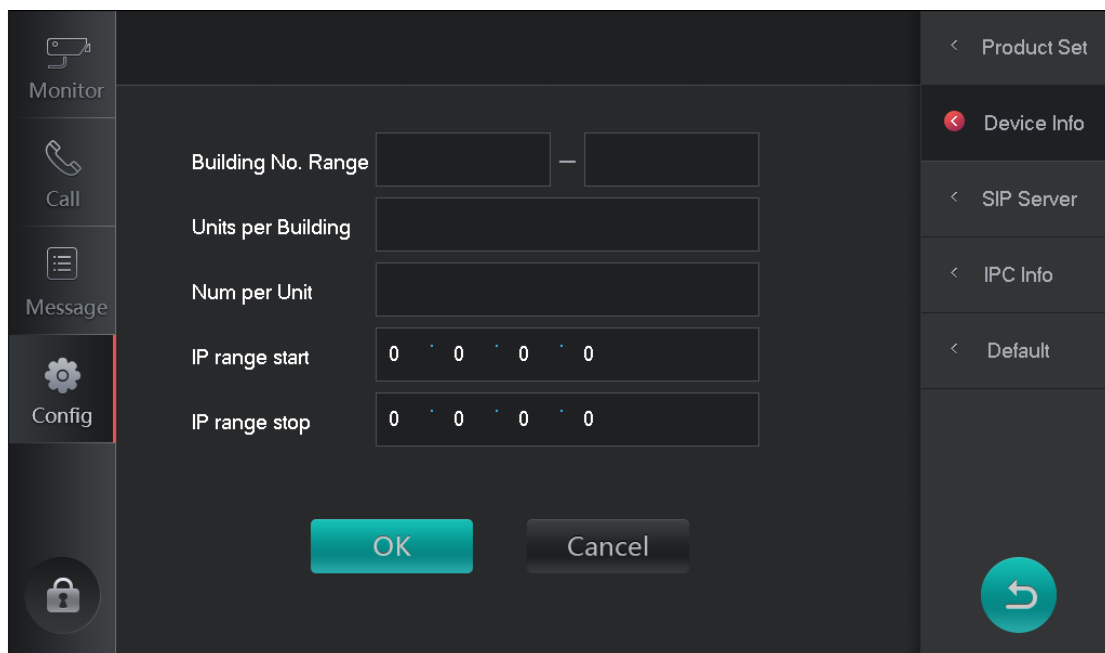

Figure 3-5

- Step 5. Enter building range, units per building and etc.
- Step 6. Click OK. System shows “please wait” interface, click OK to continue adding VTO.  
Successfully added VTO can be added in Monitor>VTO.

### 3.4. SIP Server

- Step 1. Select Config>Advance Config>SIP Server, see Figure 3-6.

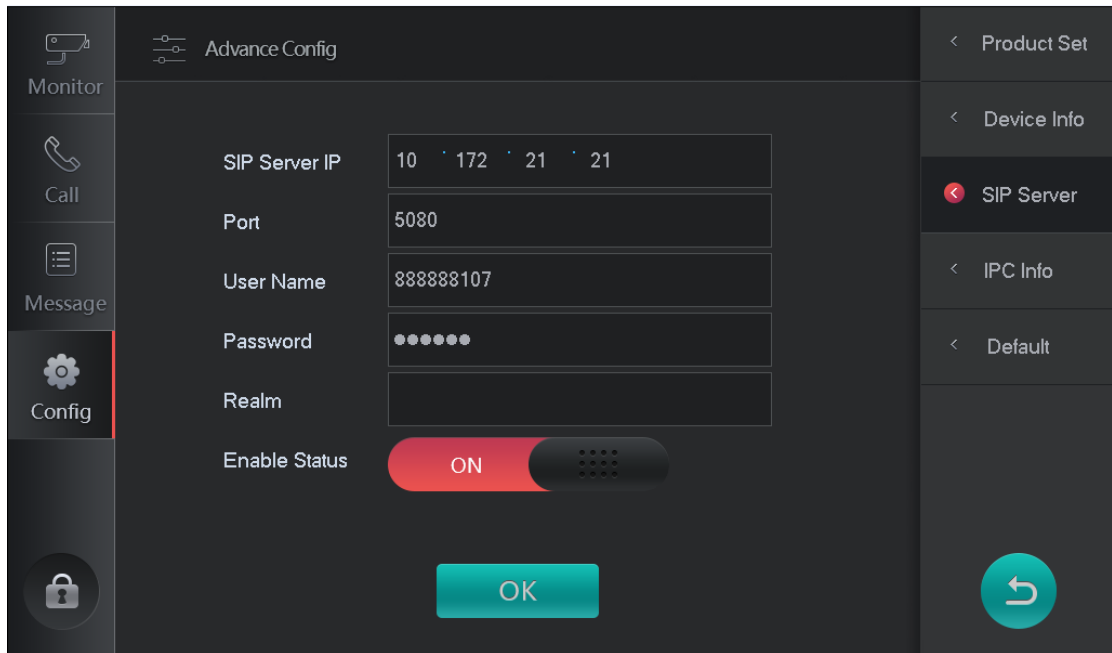

Figure 3-6

Step 2. Set parameter, see Chart 3-1.

Parameter	Note
IP Address	SIP server IP address.
Network Port	SIP server network port.
Username	Fill in VTS middle no.
Password	Default is 123456
Realm	Null by default.

Chart 3-1

Step 3. Select Enable Status to be ON.

Step 4. Click OK.

### 3.5. Add IPC

You can add up to 32 IPCs, used to VTS to motor IPC.

Step 1. Select Config>Advance Config>IPC Info. See Figure 3-7.

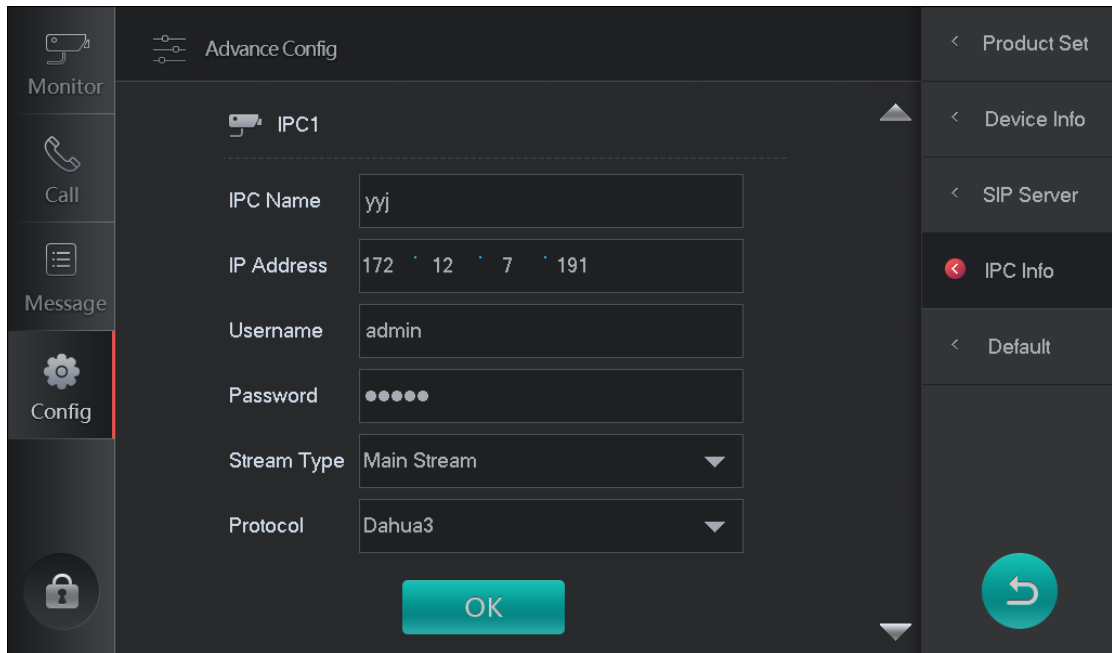

Figure 3-7

Step 2. Set interface parameter, see

Parameter	Note
IPC Name	IPC name
IP Address	IPC IP address
Username	Username and password to login IPC WEB interface
Password	
Stream Protocol	<p>According to need to select stream type, main stream and sub stream.</p> <ul style="list-style-type: none"> <li>● Main stream: large stream, high definition, high occupied bandwidth, suitable for local storage.</li> <li>● Sub stream: fluent video, low occupied band width, suitable for low bandwidth.</li> </ul>
Protocol	Local protocol and Onvif protocol, please select according to IPC

Chart 3-2

Step 3. Click OK.

You can view IPC in Monitor>IPC.

Note:

Click  to continue adding IPC.

### 3.6. Call Test

On VTS, call VTH. VTS pops up monitor video and buttons, see Figure 3-8.

Note:

You can continue to add IPC here.

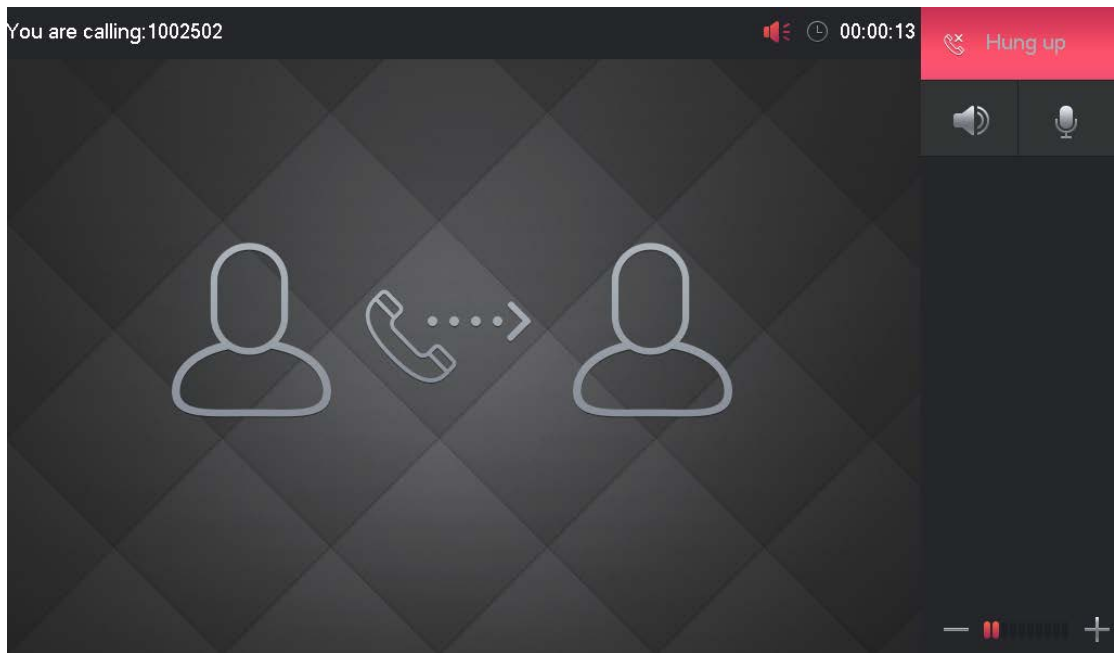

Figure 3-8

### 3.7. Default

You can go to Config>Advance Config>Default, to restore all default settings in Advance Config to default values, see Figure 3-9.

After device is set to default, device will restart.

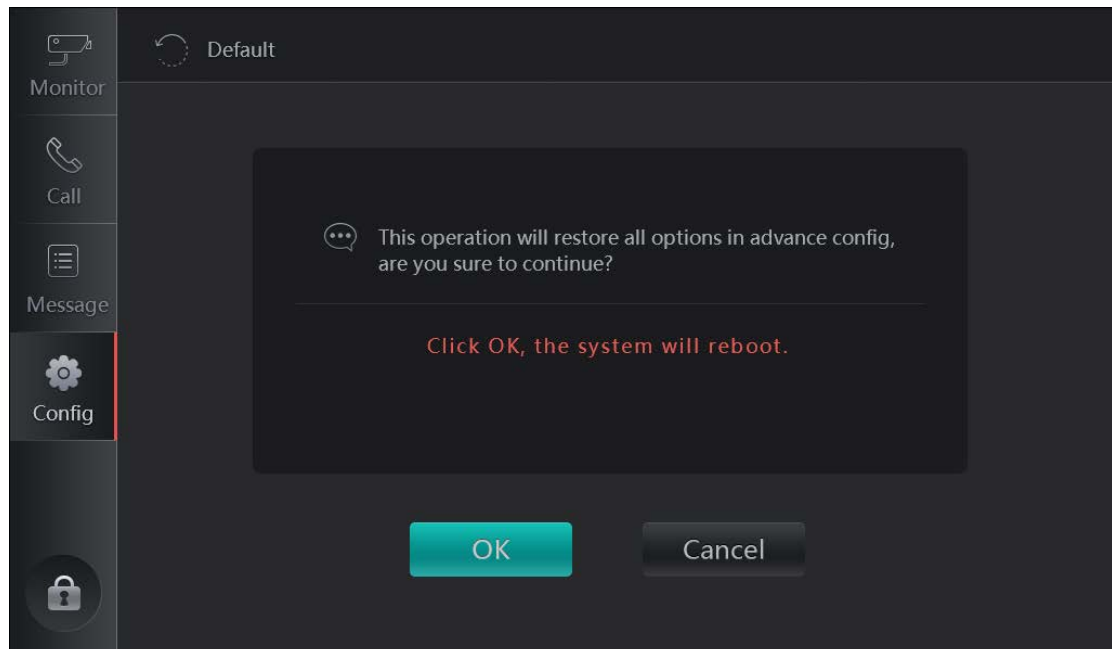

Figure 3-9



## 4. Daily Operation

### 4.1. Monitor

VTS can monitor VTO, and any other specified IPC and fence station.

Note:

- Operations to monitor VTO and to monitor IPC/fence are similar.
- To add VTO/fence station, see Ch 3.3.
- Before monitoring IPC, please add IPC, see Ch 3.5.

Step 1. Select Monitor>Door Station, see Figure 4-1.

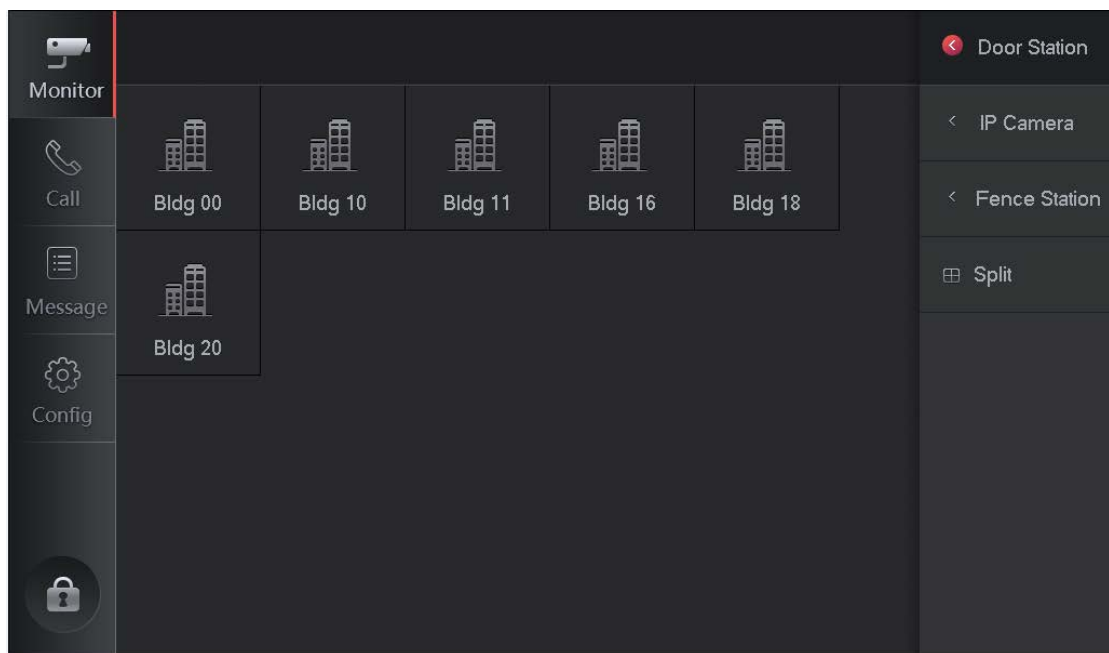

Figure 4-1

Step 2. Select VTO to be monitored. See Figure 4-2.

Note:

See Chart 4-1.

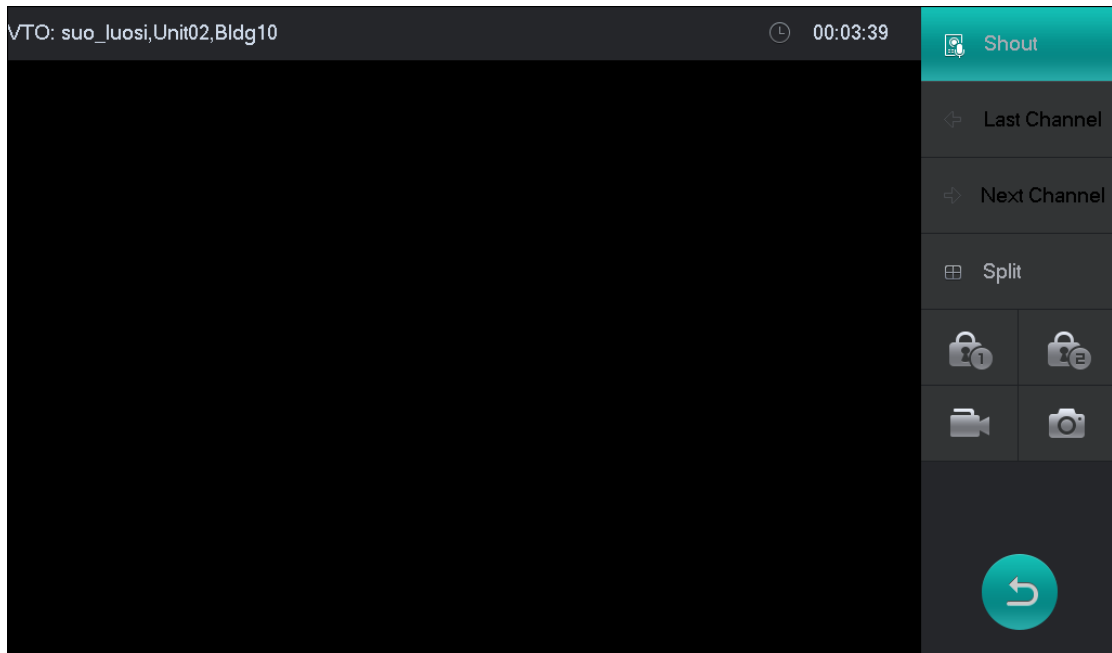

Figure 4-2



Parameter	Note
Call	Click <b>【Call】</b> , you can call VTO.
Last Channel	If one VTS monitors more than one VTO, you can click Last Channel and Next Channel to switch video.
Next Channel	
Split	If you want to vide monitoring video of VTO, you click Split toad windows, see Figure 4-3.
Unlock	Click Unlock to unlock VTO.
Record	Click  to start record/end record.
Snapshot	Click  to snapshot.
Note: <ul style="list-style-type: none"> <li>• When SD card is not plugged, icon is grey.</li> <li>• Snapshot and record are saves in SD card.</li> </ul>	

Chart 4-1

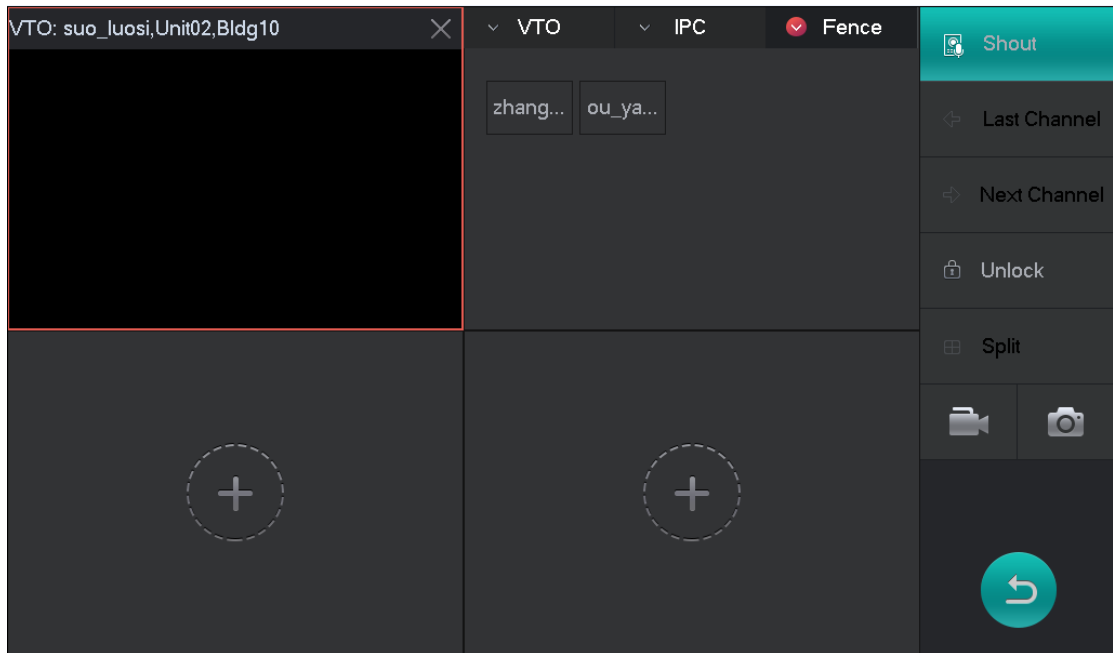

Figure 4-3

## 4.2. Call

### 4.2.1. Shout

When a VTS monitors VTO/fence station, click Shout, see Figure 4-4.

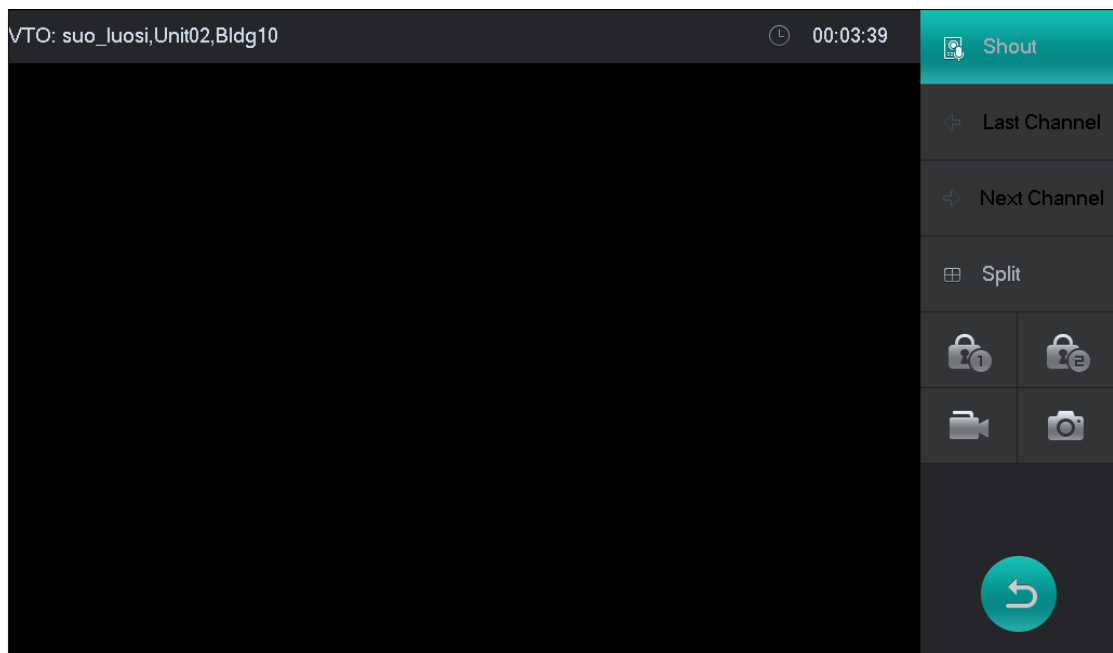



Figure 4-4

Note:

According to VTO type, show number of lock, such as  and . See Chart 4-1.

## 4.2.2.Call Resident

Enter Building-unit-room no., to call corresponding user.

Step 1. Select Call>Dial, see Figure 4-5.

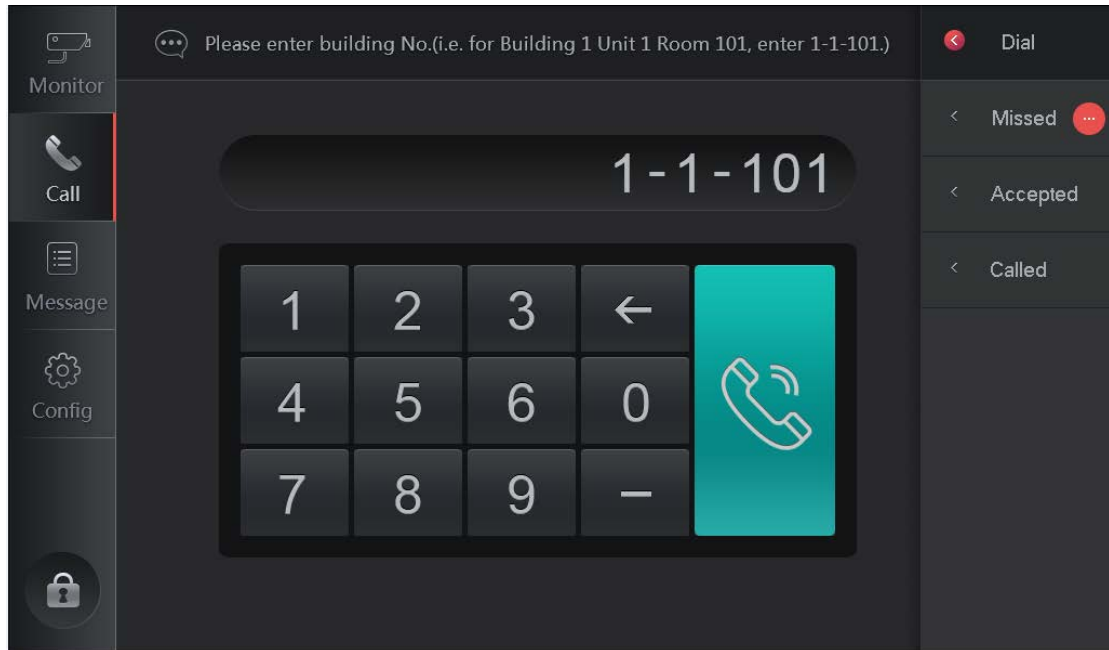



Figure 4-5

Step 2. Enter room no. of resident you want to call, click . When the resident accept call, you can have a bidirectional talk. See Figure 4-6.

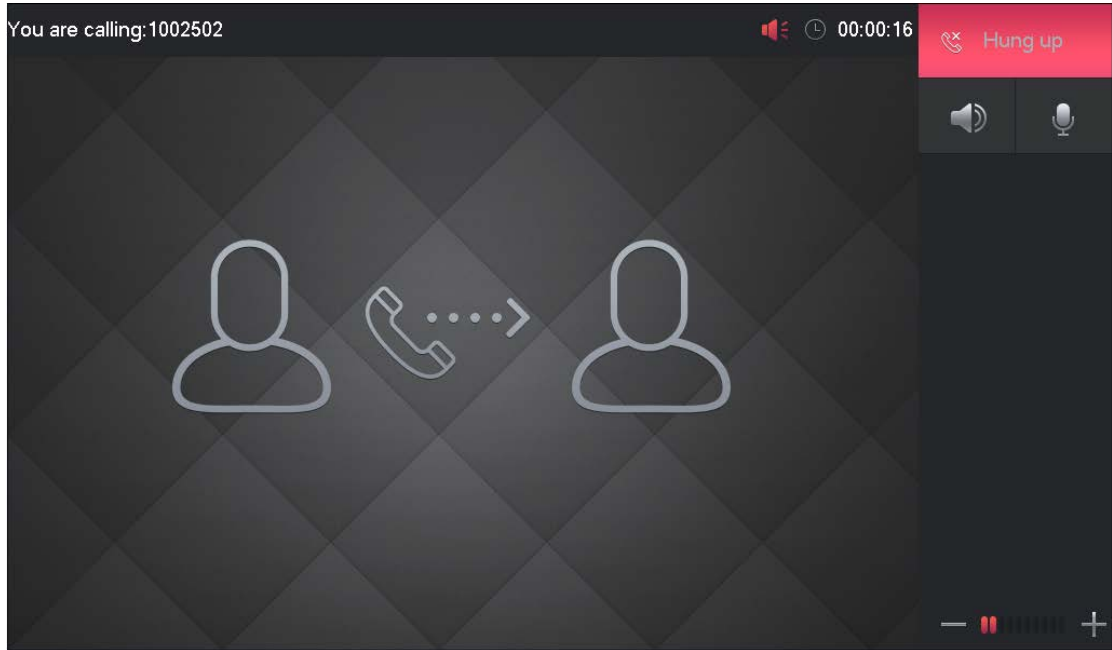

Figure 4-6









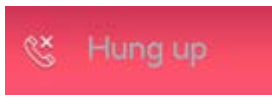

Icon	Name	Note
	Hang up	For incoming call, click  to hang up.
	Speaker	Used to turn on/off VTS audio output
	MIC	Used to turn on/off VTS audio input
	Record	Click  to start to record and click  to end recording.
	Snapshot	Click  to snapshot
	Volume	Adjust VTS volume

Chart 4-2

### 4.2.3.Call Record

You can view, clear VTS accepted call, missed call and called call.  
For example, to view missed call.

Step 1. Select Call>Missed, see Figure 4-7.

Note:

- White text, means the records have been viewed.
- Orange text, means the records have not been viewed.
- Missed call with  means the missed call has record or snapshot, you can manually record or snapshot when you are calling or on a call.

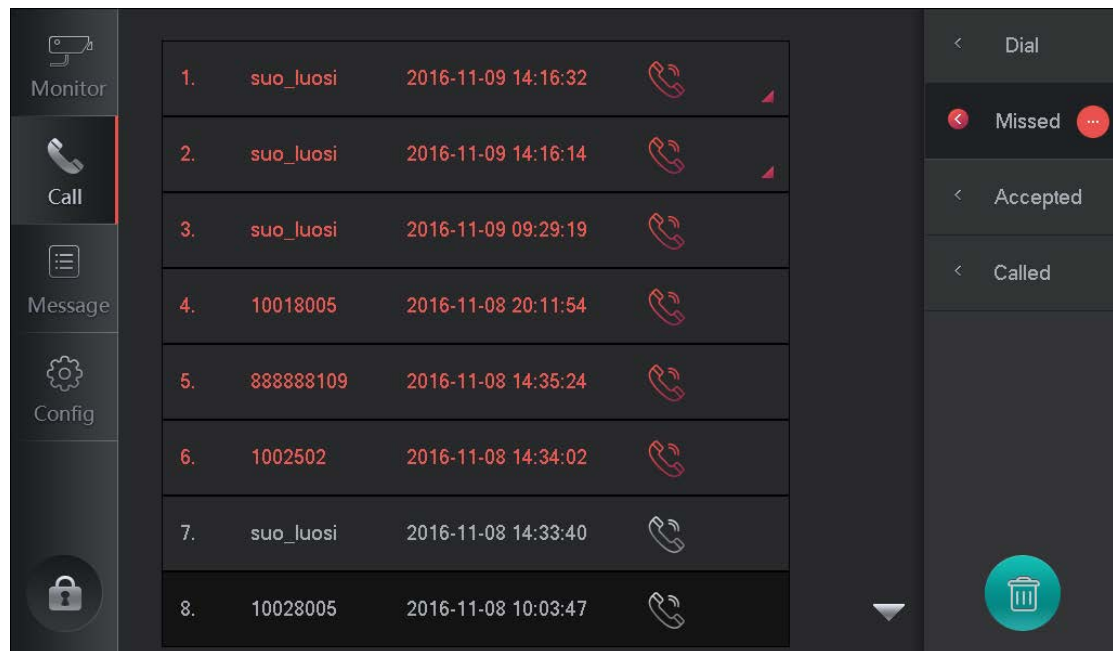

Figure 4-7

Step 2. Select missed call you want to view, click .

See Figure 4-8.

Note:

You can click  to clear all records.

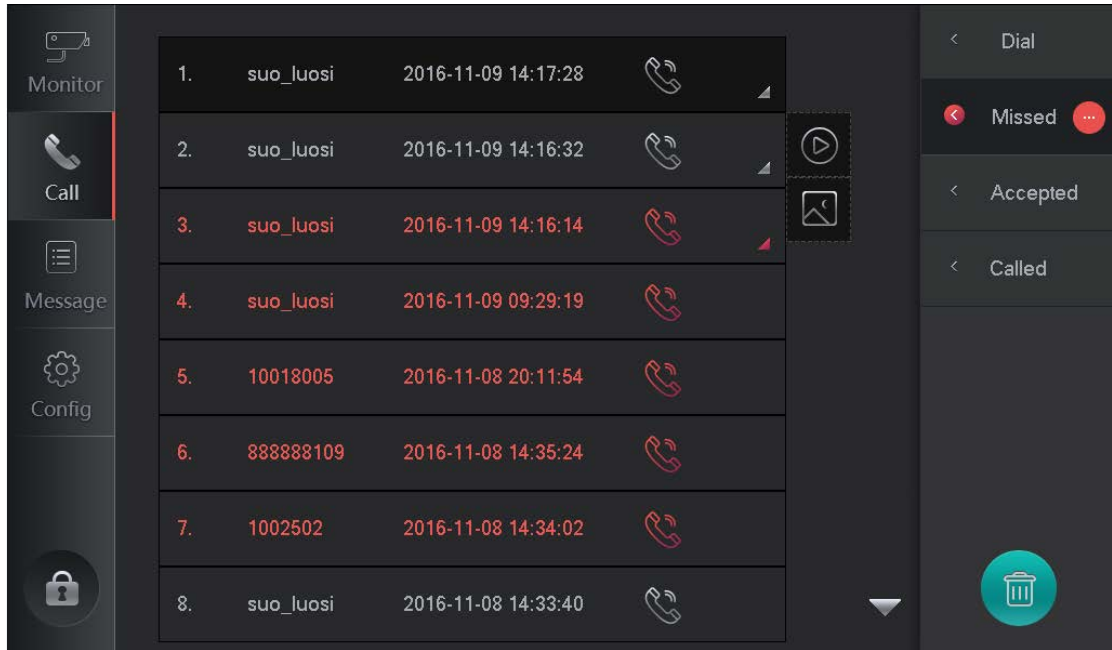

Figure 4-8

Step 3. Click  or  to view record or snapshot details.

### 4.3. Message

You can go to Message interface, view, clear VTO/fence station record, snapshot. For example to view record.

Step 1. Select Message> All Devices>Record. See Figure 4-9.

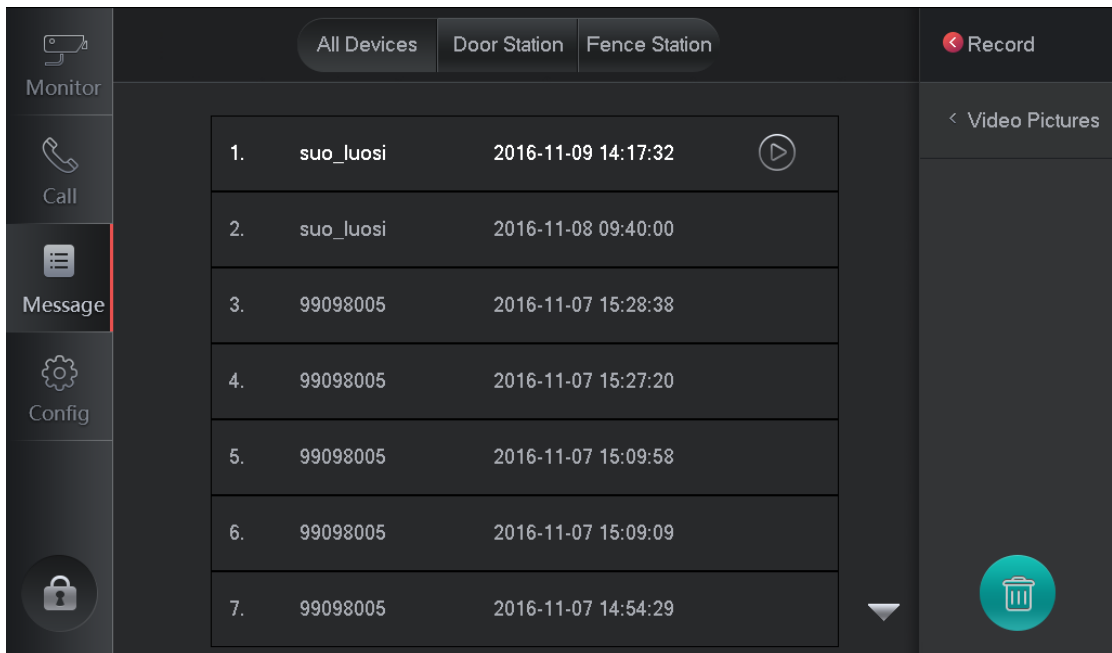



Figure 4-9

Step 2. Click  to select device record. See Figure 4-10.

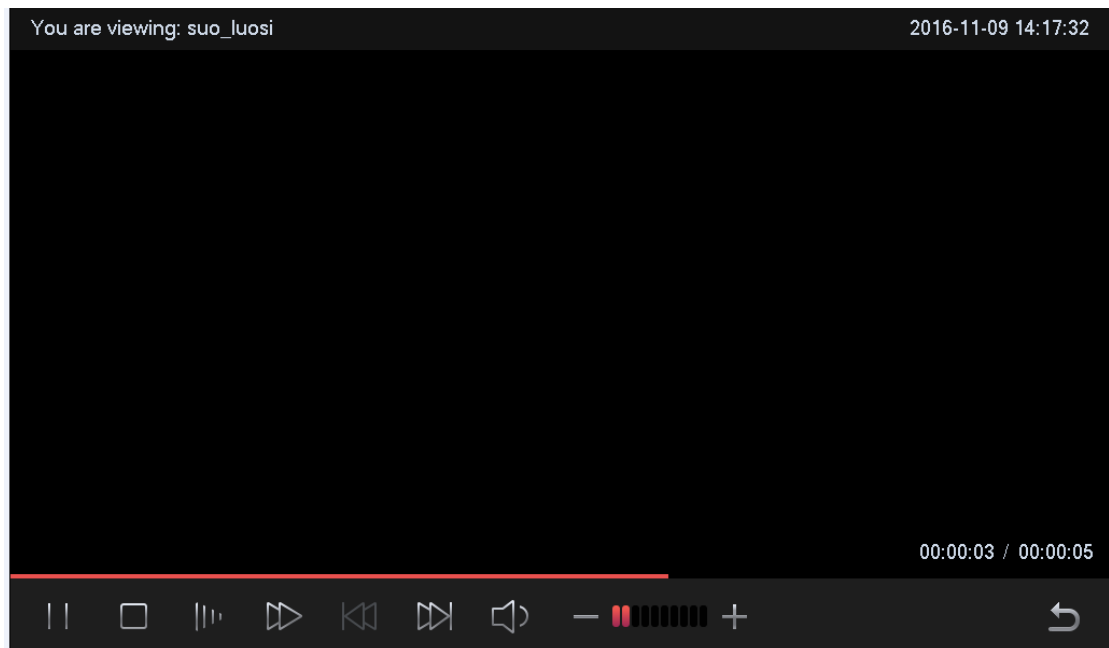

Figure 4-10









Icon	Note
	Pause
	Stop
	Slow play
	Fast forward
	Previous channel
	Next channel
	Volume ON/OFF
	Adjust record volume

Chart 4-3

## 4.4. Unlock

When the VTO is being called, monitoring, on a call, you can click Unlock button on the



device to remotely unlock VTO lock.

## **4.5. Version**

You can go to Config>Advance Config<Version interface, view device MAC address and software version.

Note:

Login Advance Config, default password is 888888, and this password cannot be changed.

## **4.6. Basic Config**

You can go to Config interface to set VTS display, ring, SD card and talk length.

### **4.6.1.Display**

You can go to Config>Display, adjust screen brightness and screen saver.

### **4.6.2.Ring**

#### **4.6.2.1. Phone Ring**

You can go to Config>Sound>Phone Ring interface, select incoming call ring and volume, see Figure 4-11.

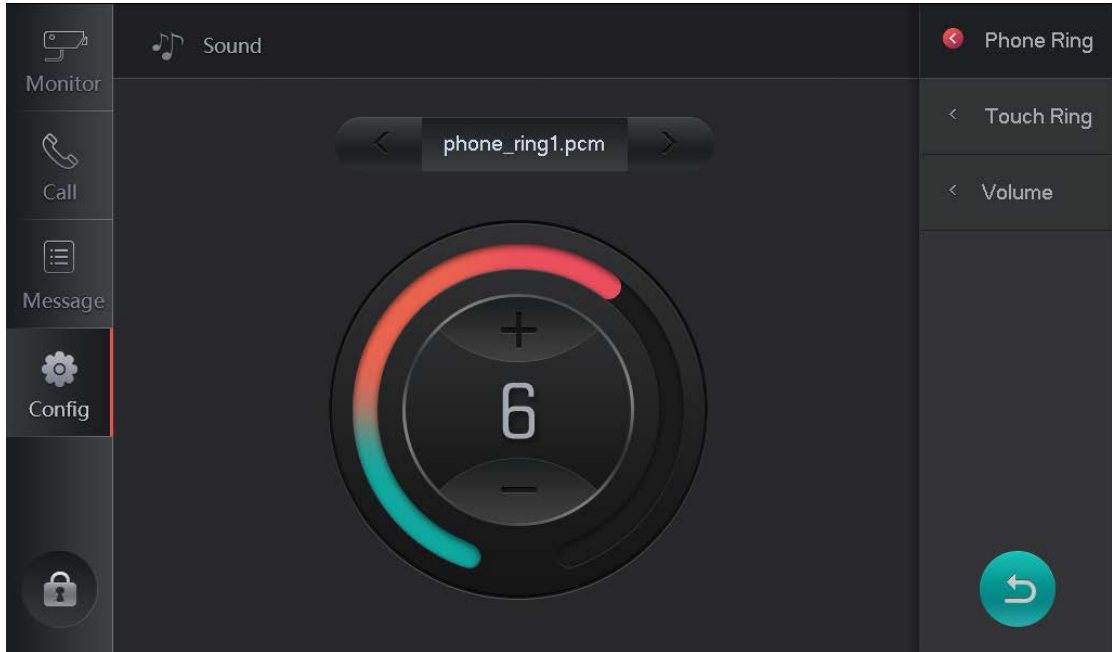

Figure 4-11

#### 4.6.2.2. Touch Ring

You can go to Config>Sound>Touch Ring interface, turn on/off tone of touch.

#### 4.6.2.3. Volume

You can go to Config>Sound>Volume to adjust VTS talk volume.

### 4.6.3. Talk Time

You can go to Config>Talk Time, set VTO talk time, VTH ring time and etc, see Figure 4-12.



Figure 4-12

#### 4.6.4.SD Card

You can go to Config>User>SD Card, click SD card to view free space or format SD card.

#### 4.6.5.Default

You can go to Config interface, click Default button, and in pop up box click OK to restore default settings for display, ring and talk. See Figure 4-13

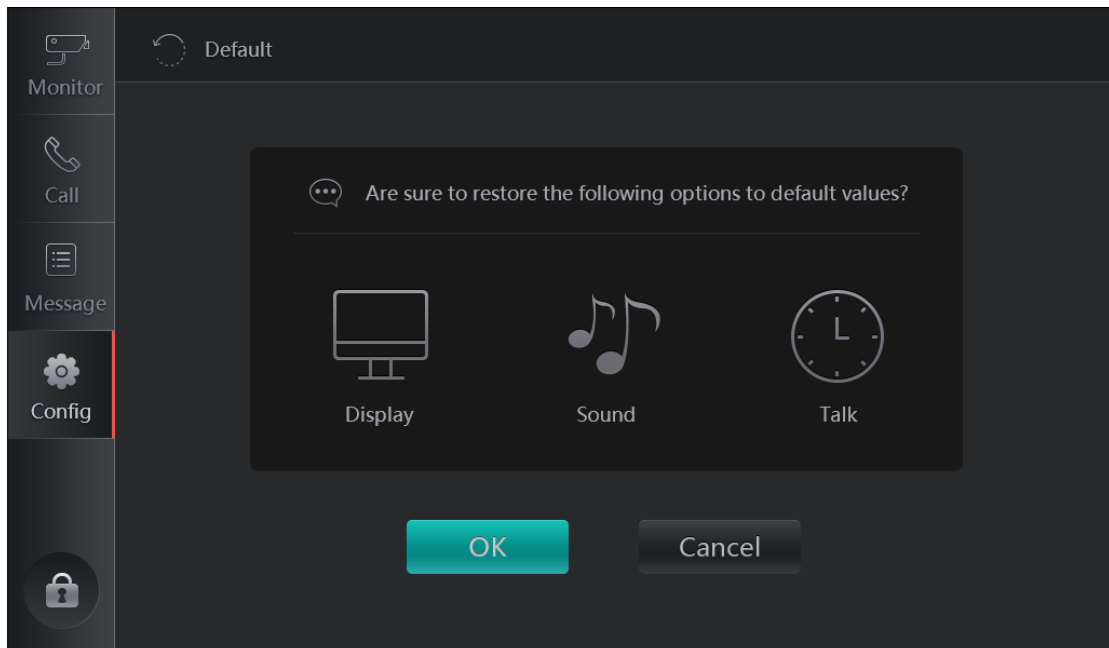

Figure 4-13

## Appendix 1

<b>System</b>	
Main Processor	Embedded microprocessor
OS	Embedded LINUX OS
<b>Video</b>	
Video Compression Standard	H.264
Video Output	HDMI output, resolution 1024*600
<b>Audio</b>	
Input	Omni directional MIC, pick up、gooseneck MIC (optional)
Output	Built-in speaker, MIC speaker
Talk	Bidirectional talk
<b>Display</b>	
Screen	10 inch HD LCD
Video Resolution	1024x600
<b>Operation Mode</b>	
Input	Mechanical keypad (hands free, unlock) , capacitive touch screen
<b>Alarm</b>	
Alarm Input	4-ch
Alarm Output	1-ch
<b>Extension Port</b>	
RS485	1-ch
USB	2-ch
SD Card	Max 32G
Power Output	Follow input voltage, limit 0.8A
<b>Network</b>	
Ethernet	10M/100Mbps self-adaptive
Network Protocol	TCP/IP
<b>General</b>	
Power	DC 24V
Consumption	Standby ≤4W; work≤8W (without power output)
Environment	-10℃~+55℃
	10%~90%RH
Dimensions	345mm×224.6mm×28mm

(LxWxH)	
Weight	1.5kg

**Note:**

- **This manual is for reference only. Slight difference may be found in the user interface.**
- **All the designs and software here are subject to change without prior written notice.**
- **All trademarks and registered trademarks mentioned are the properties of their respective owners.**
- **If there is any uncertainty or controversy, please refer to the final explanation of us.**
- **Please visit our website or contact your local retailer for more information.**